

Forme · Formes · Shapes · Formen · Formas

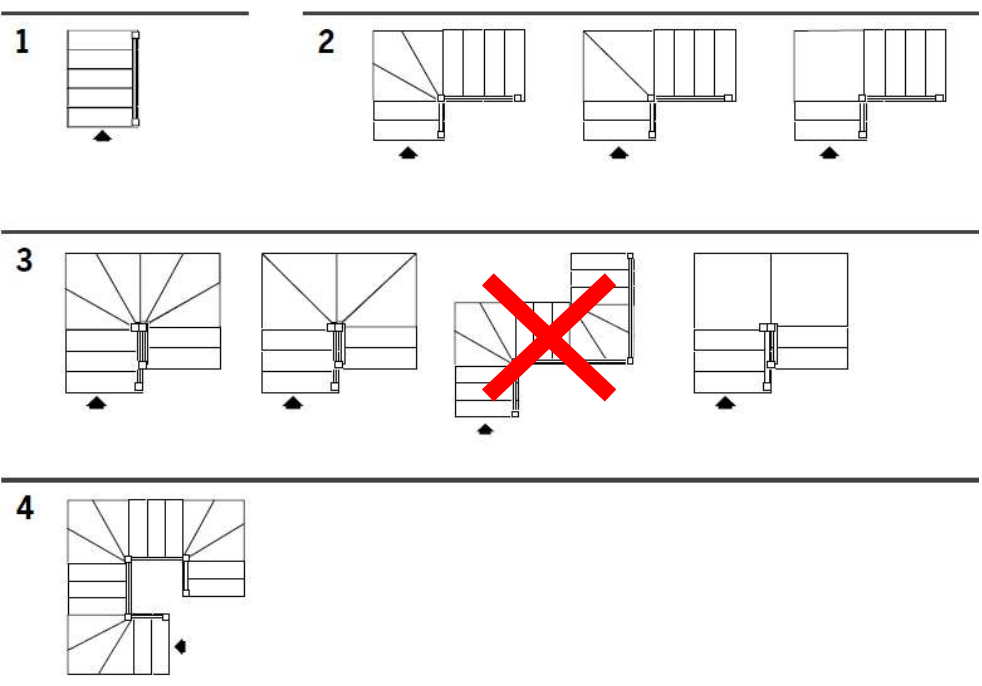

| | G10 | G11 | G12 | G13 | G14 | G15 | G16 | G17 |
|---|------|------|------|------|------|------|------|------|
| h | h | h | h | h | h | h | h | h |
| | 1870 | 2040 | 2210 | 2380 | 2550 | 2720 | 2890 | 3060 |
| | 2310 | 2520 | 2730 | 2940 | 3150 | 3360 | 3570 | 3780 |



Caratteristiche tecniche

Technical specifications
Spécifications techniques
Technische Daten
Características técnicas

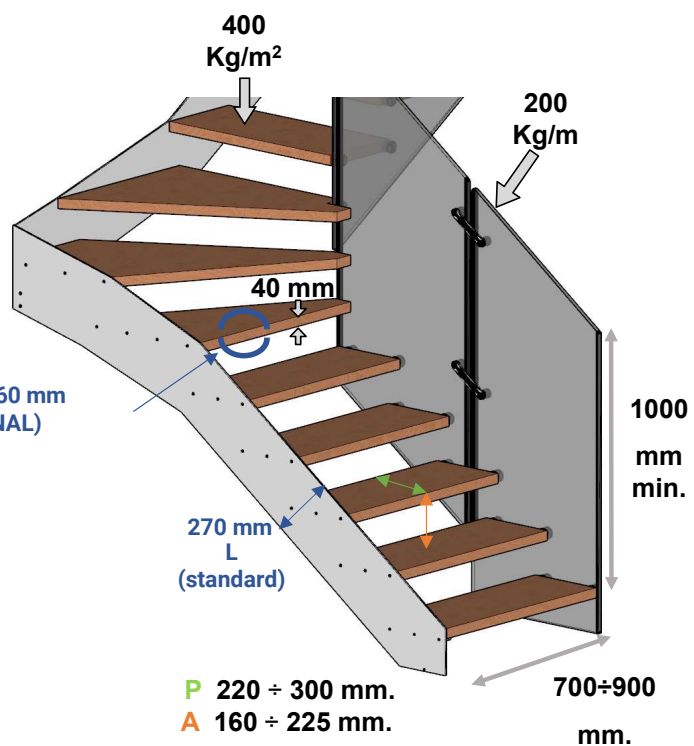

REXAL MONO XR

Tipologie di legno disponibili

Type of Wood
Type de bois
Holzart
Tipo de madera



Faggio
Beech
Hêtre
Buche
Haya



Rovere
Oak
Chêne
Eiche
Roble

Calcolo passaggio utile

Useful passage - passage utile
-nützliche Passage - Pasaje útil

$$L - R (21,52 \text{ mm}) = P$$

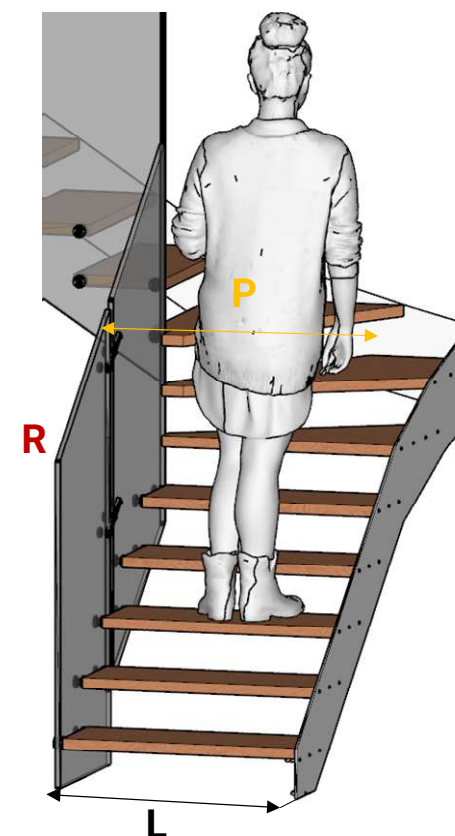

ARRIVO CON ALZATA
ARRIVAL WITH RISER
ARRIVÉ AVEC HAUTEUR
ANKUNFT MIT STEIGUNG
LLEGADA CON CONTRAHUELLA

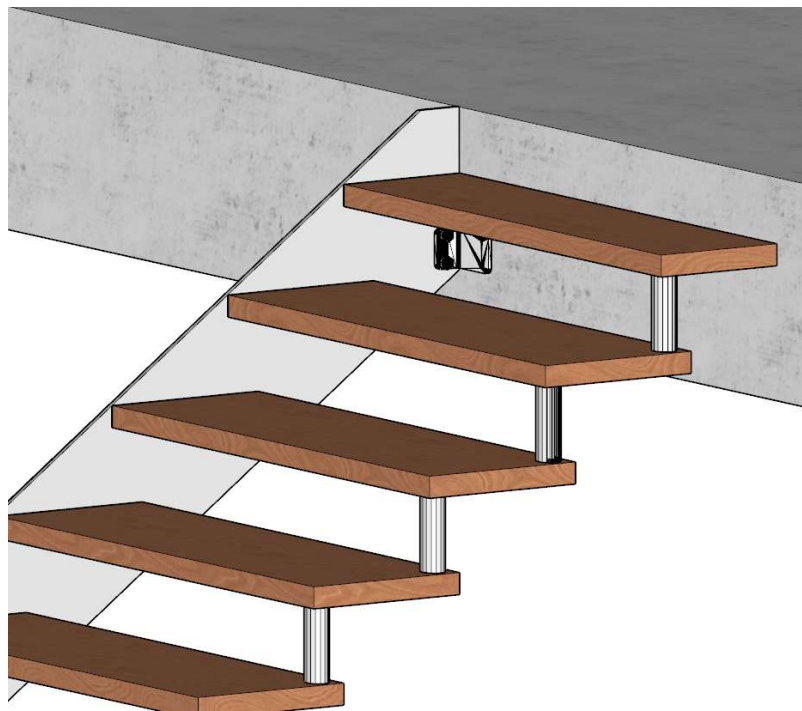

ARRIVO PARI PAVIMENTO
ARRIVAL AT SAME FLOOR LEVEL
ARRIVÉE AU MÊME NIVEAU DU SOL
ERREICHUNG GLEICHEN NIVEAU DES BODENS
LLEGADA MISMO NIVEL QUE EL SUELO

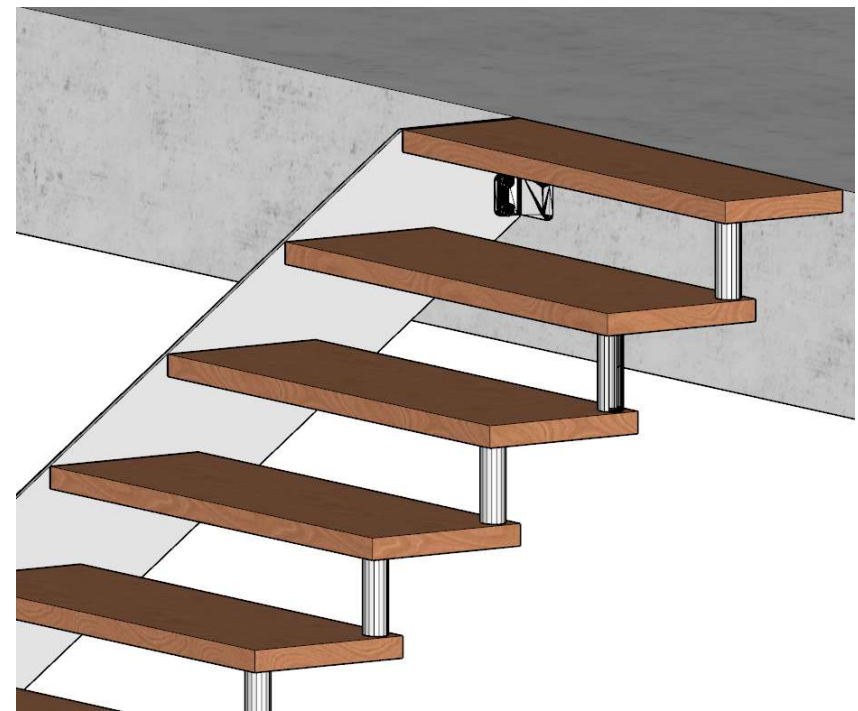

REXAL MONO XR

PARTENZA DA PAVIMENTO
FLOOR DEPARTURE - DÉPART DU SOL - ABGANG VOM
BODEN – SALIDA DESDE EL SUELO

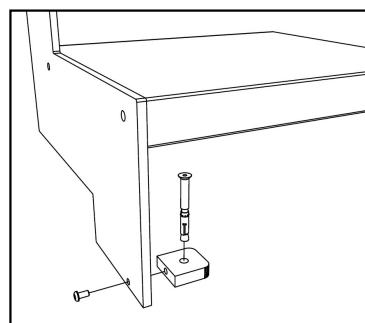
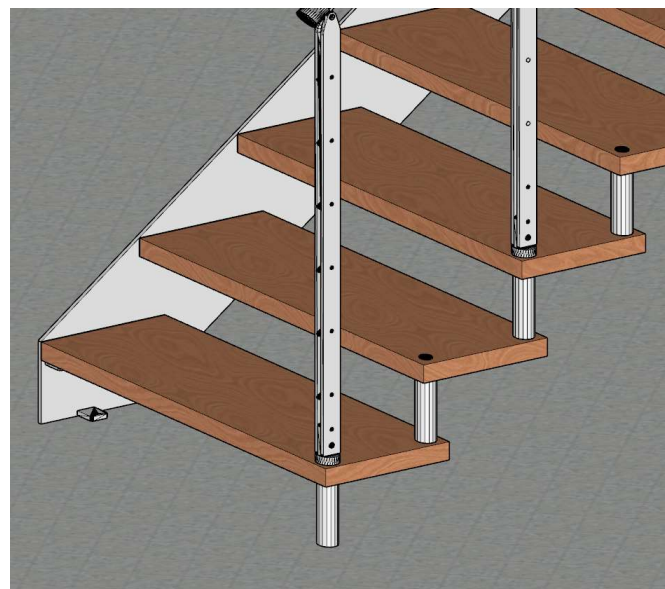

FISSAGGIO A PAVIMENTO
FLOOR FIXING
FIXATION AU SOL
BODENBEFESTIGUNG
FIJACIÓN DEL SUELO

REXAL MONO XR

BALAUSTRE DISPONIBILI

Available Floor Protection Balustrade – Garde-corps étage disponibles –
Schutzgeländer verfügbar - Barandillas disponibles

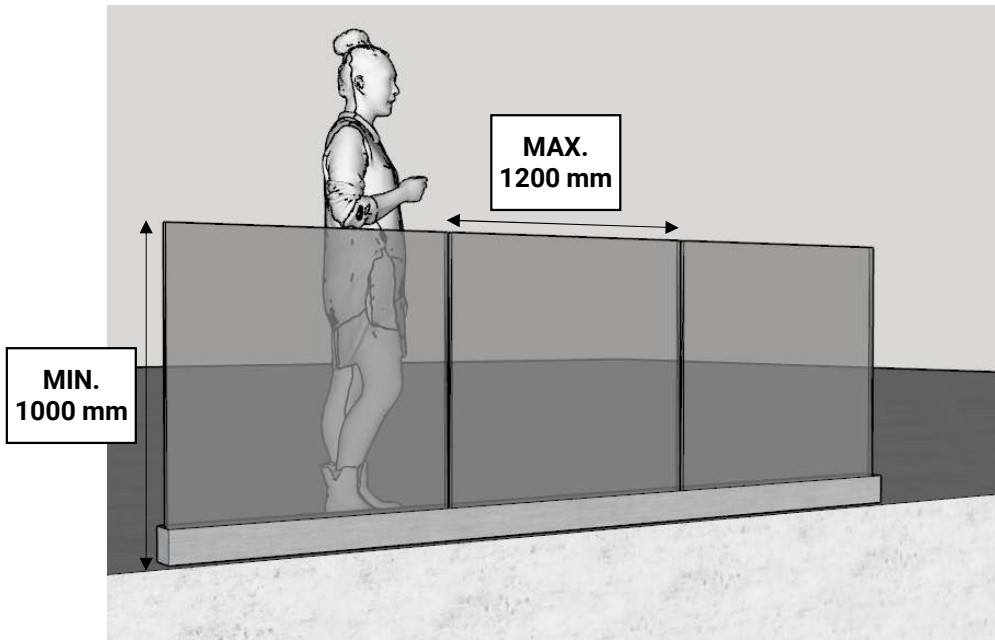

TRACK P

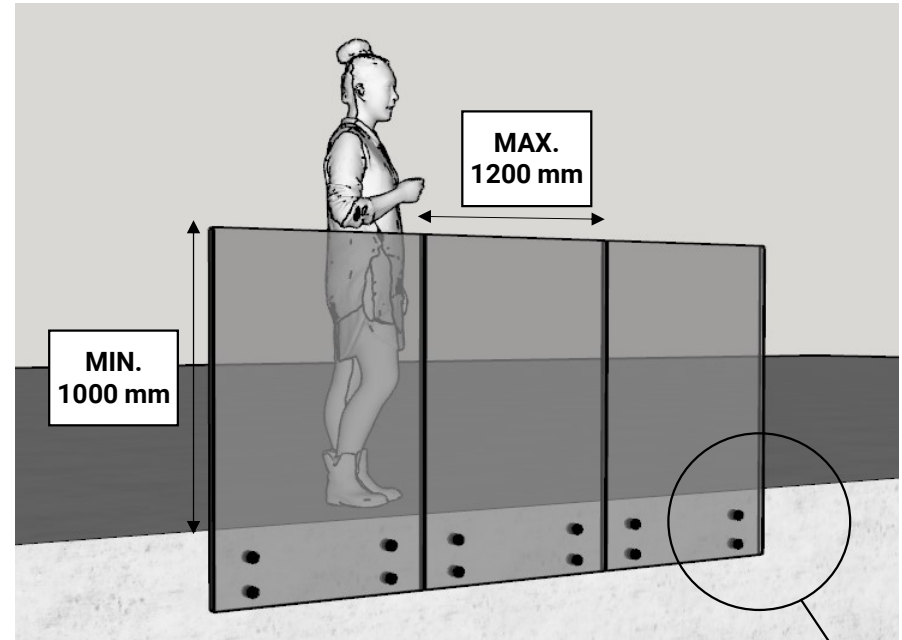

XR

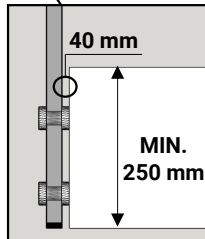

Alzate chiuse Closed Risers – Contremarches
- Setzstufen – Contrahuella cerrada

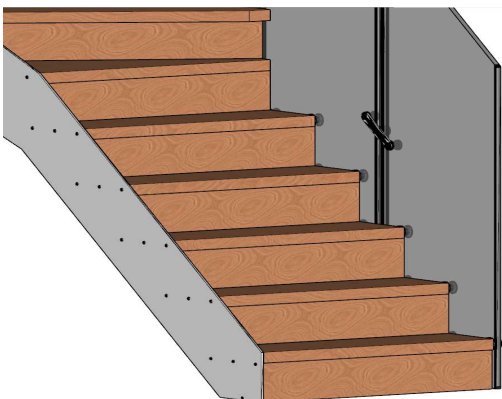

Corrimano a muro- Wall handrail – Main courante murale - Wandhandlauf - Pasamanos de pared



REXAL MONO XR

Angolo per pilastro (max 3 gradini) – Corner for Pillar (max 3 steps) – Angle pour Poteau (max 3 marches)
- Winkel pro Säule (Max 3 Sufen) - ángulo por pilar (máximo 3 escalones)



Larghezza scala

Staircase width – Largeur escalier – Breite der Treppe - Anchoe escalera

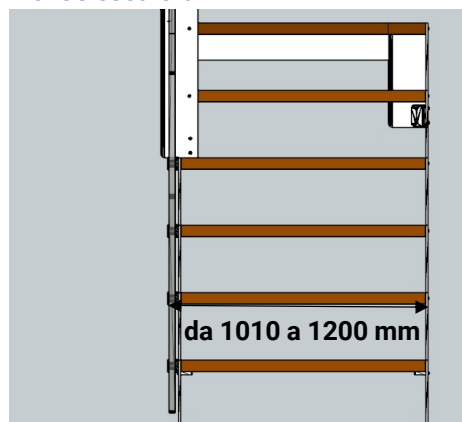

Scala fuori squadra
Out-of-square stair -Escalier hors équerre –
Unregelmäßige Treppe –
Escalera fuera de escuadra

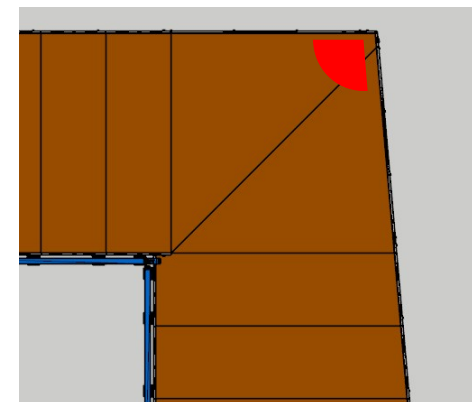

Soglia - Threshold – Seuil – Schwellenwert - Umbral

